

Underfloor Air Terminal (Constant Volume Ducted)

MODEL: **PCD - 08R - B**

DESCRIPTION:

PCD-08R-B (Personal Comfort Diffuser) is an adjustable ducted constant volume diffuser for use in raised floor air systems. The underfloor terminal features 20 gauge (1mm) galvanized steel construction, pre-painted flat black.

The ellipsoid collar accepts a standard 6"Ø (152mm) flex duct connection. Air flow capacity is derived from the source; output is dependent on ducting arrangement and fan capability.

The nominal 8" (203mm) diameter cast aluminum grille produces 180 degree uni-directional mixing air flow. A manually adjustable sliding damper allows space occupants to limit maximum air flow. Ten (10) standard grille colors are available; custom colors and finishes can be provided to match architectural design (specify on order).



FEATURES:

- Manual air flow adjustment with sliding damper plate
- Accepts standard 6"Ø (152mm) flex duct connection
- Redirect air flow by rotating grille
- Nonbinding flow adjustment
- Omni-directional air flow
- Tight shut-off

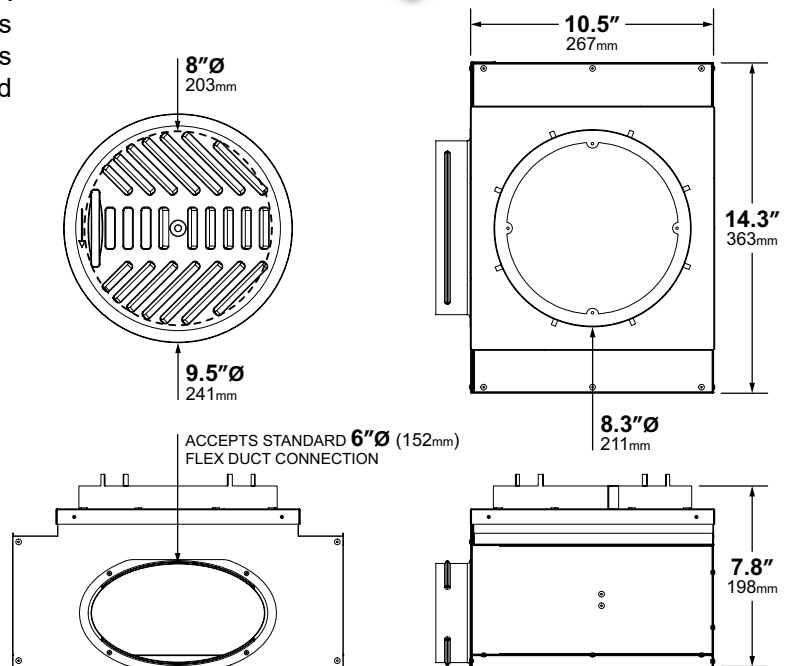
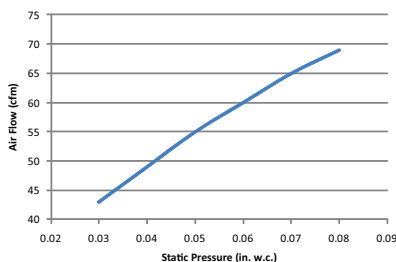

ALL DIMENSIONS NOMINAL +/- 0.1" (2.5mm)

SPECIFICATIONS:

Application:	Underfloor Heating / Cooling Raised Access Floors 8" (203mm) +
Grille Dimensions:	Diffuser Opening: 8"Ø (203mm) Full Face: 9.5"Ø (241mm)
Diameter (Nominal)	Installation Cut-Out: 8.4375"Ø [+1.125/-0.00] (214mm [+3.175/-0.00])
Grille Rating:	Cast Aluminum Conforms to NFPA 90a 1250 lbs. (567 Kg) Load Strength
Supply Press. / Temp.:	0.02–0.1 in. w.c. (5–25 Pa) 40–140°F (4–60°C)
Capacity:	Maximum: 55 cfm @ 0.05 in. w.c. (94 m³/hr @ 12.5 Pa)
(Nominal)	Minimum (Damper Closed): 14 cfm @ 0.05 in. w.c. (24 m³/hr @ 12.5 Pa)
	Air Flow Dependant on Duct Supply Conditions Duct Connection: 6"Ø (152mm)
Noise Criterion:	≤ NC-17 (All Flow Conditions)